

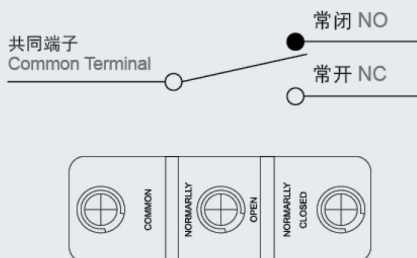

### 特点 Features

- 引动器种类广泛，其中包含动作位置可调整的款式（如 CM1701）
- 高精度广泛操作速度范围
- Various actuators and some with adjustable operating position (such as CM1701)
- High accuracy wide range of operation speed

### 接点型式 Contact Form



### 额定值 Ratings

额定电压 Rated Voltage	非电感性负载 Noninductive Load (A)				电感性负载 Inductive Load (A)				突入 电流 (A) Inrush Current	
	电阻性负载 Resistance Load		灯泡负载 Lamp Load		电感性负载 Inductive Load		马达负载 Motor Load			
	NC	NO	NC	NO	NC	NO	NC	NO	NC	NO
125VAC	15		3	1.5	15		5	2.5	30 以下 max.	15 以下 max.
250VAC	15		2.5	1.25	15		3	1.5		
500VAC	3		1.5	0.75	2.5		1.5	0.75		
8VDC	15		3	1.5	15		5	2.5		
14VDC	15		3	1.5	10		5	2.5		
30VDC	6(2)		3	1.5	5		5	2.5		
125VDC	0.4		0.4	0.4	0.05		0.05	0.05		
250VDC	0.2		0.2	0.2	0.03		0.03	0.03		

### 规格 Specifications

操作速度 Operation speed	0.05mm 至 1m/s(柱塞型 Plunger type) 0.05mm-1m/s
动作频率 Operating frequency	电气 :20 次 / 分 Electrical: 20 operations/min.
接点电阻 Contact resistance	15mΩ 以下 (初期) 15mΩ max. (initial value)
绝缘电阻 Insulation resistance	100mΩ 以上 (在 500VDC 以下) 100mΩ min. (at 500VDC)
电介强度 Dielectric Strength	非连续端子间 1,000VAC, 50/60Hz 持续 1 分钟 1000VAC, 50/60 Hz for 1 minute between terminals of the same polarity
	载电流与无载电流零件间 1,500VAC, 50/60Hz 持续 1 分钟 1500VAC, 50/60 HZ for 1 minute between current-carrying and non-current-carrying metal parts
	端子和接地之间 1,500VAC, 50/60Hz 持续 1 分钟 1500VAC, 50/60 HZ for 1 minute between each terminal and ground
振动 Vibration	(*10 至 20Hz): 1.5mm 变振幅误动作耐久: 10 至 55Hz (*10 to 20Hz): 1.5 Vibration amplitude action duration: 10 to 55Hz
冲击 Shock	机械耐久: 1,000m/Sec <sup>2</sup> (约 100G' S) 误动作耐久: 300m/Sec <sup>2</sup> (约 30G' S) Mechanical durable: 1,000m/Sec <sup>2</sup> (about 100G'S) Malfunction: 300m/Sec <sup>2</sup> (about 30G'S)
周围温度 Ambient temperature	使用时: -20~+80°C (没有结冰) Using: -20~+80°C (With no icing)
湿度 Humidity	泛用型: 85%RH 以上 密封型: 95%RH General purpose type: 85% RH max., Sealed type: 95% RH max.
电气寿命 Electrical life	500,000 次以上 500,000 operations above
重量 Weight	约 22 至 58g About 22 to 58g

# CM 卧式限位开关 Horizontal Limit Switch

## 动作特性 Operating Characteristics

型式 Models	CM1300	CM1301	CM1303 CM1303M	CM1305	CM1306	CM1307	CM1308 CM1308X	CM1309	CM1701 CM1706	CM1702	CM-1703 CM-1703M	CM-1704 CM-1704M	CM1705	CM-1743 CM-1743M	
OF 最大 (Max.)	350g	300g	300g	350g	350g	350g	350g	350g	70g	160g	100g	160g	10g	160g	
RF 最小 (Min.)	114g	50g	50g	114g	114g	114g	114g	114g	14g	28g	22g	42g	3g	42g	
PT 最大 (Max.)	0.4mm	4mm	4mm	0.4mm	0.4mm	0.4mm	0.4mm	0.4mm	10mm	5mm	7.1mm	2.7mm	20mm	2.7mm	
OT 最小 (Min.)	0.13mm	1.6mm	1.6mm	1.6mm	1.6mm	5.5mm	3.58mm	3.58mm	5.6mm	2mm	4mm	2.4mm	5.6mm	2.4mm	
MD 最大 (Max.)	0.05mm	1.3mm	1.3mm	0.05mm	0.05mm	0.05mm	0.05mm	0.05mm	1.27mm	1mm	1.02mm	0.5mm	3mm	0.5mm	
FP 最大 (Max.)		20.6mm	31.8mm						28.2mm	24.8mm	36.5mm	32.5mm		43.6mm	
OP(mm)	15.9 ± 0.4	17.4 ± 0.8	28.6 ± 0.8	28.2 ± 0.5	21.5 ± 0.5	21.8	0.8	33.4 ± 1.2	33.4 ± 1.2	19 ± 0.8	19 ± 0.4	30.2 ± 0.8	30.2 ± 0.4	19 ± 0.8	43.1 ± 0.8

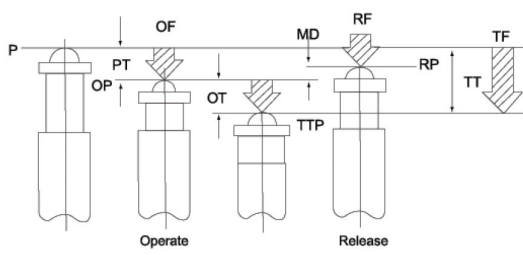

OF: 动作力  
RF: 回复力  
TF: 总行程动作力  
FP: 自由位置  
OP: 动作位置  
RP: 返回位置  
TTP: 总行程位置  
PT: 预行程位置  
OT: 过行程  
MD: 响应差的行程  
TT: 总行程

OF: Operating Force  
RF: Releasing Force  
TF: Total Force  
FP: Free Position  
OP: Operating Position  
RP: Releasing Position  
TTP: Total Travel Position  
PT: Pre Travel  
OT: Over Travel  
MD: Movement Differential  
TT: Total Travel

## 外观和尺寸 Appearance and Dimension

CM-1701

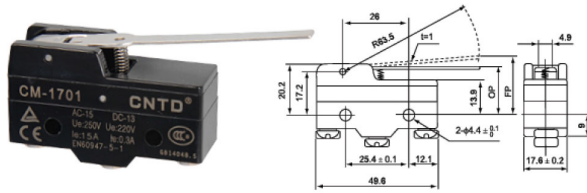

CM-1702

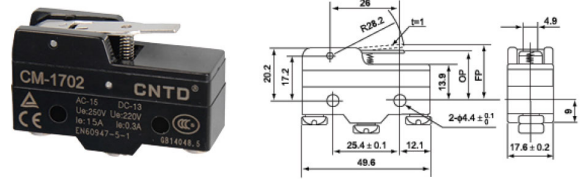

CM-1703

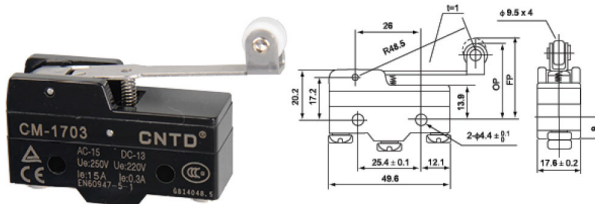

CM-1703M

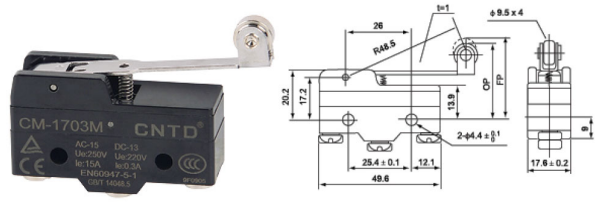

CM-1704

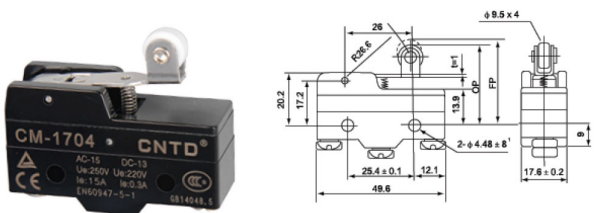

CM-1704M

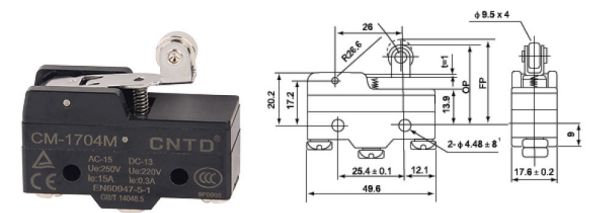

外观和尺寸 Appearance and Dimension

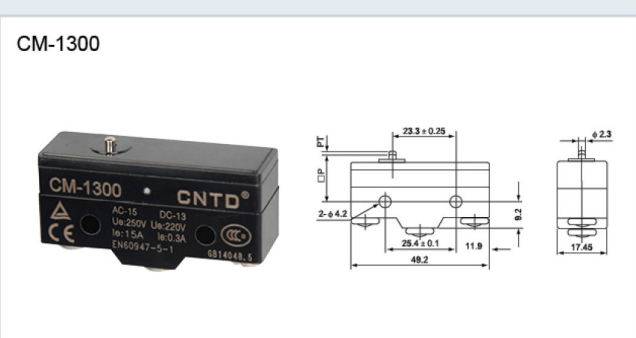
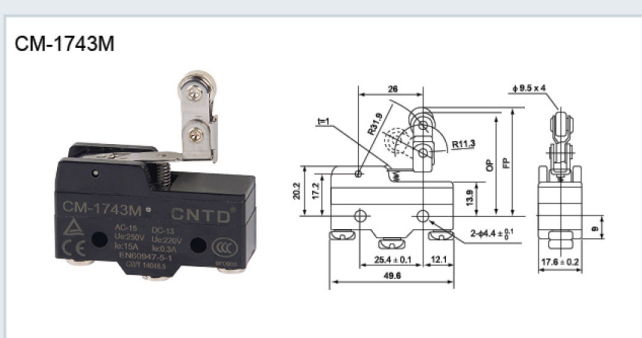
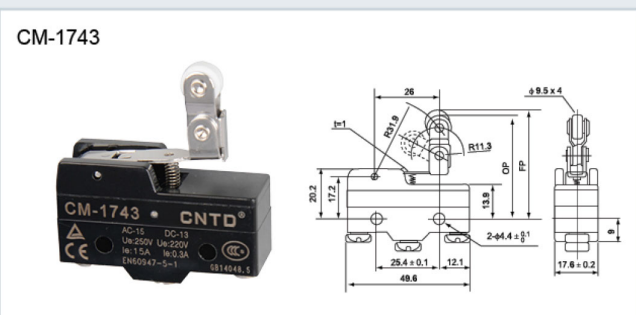
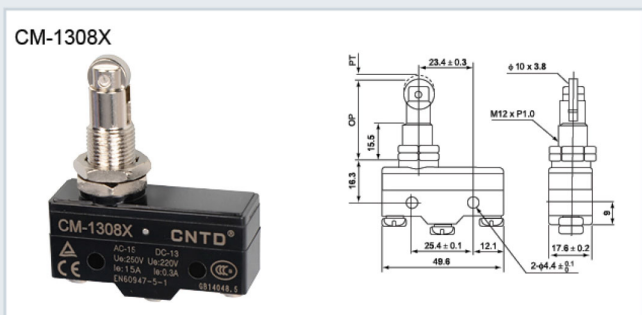
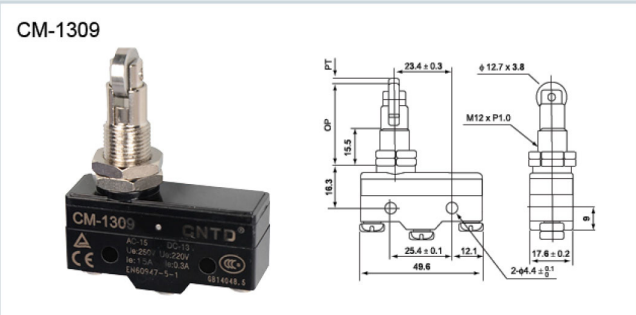
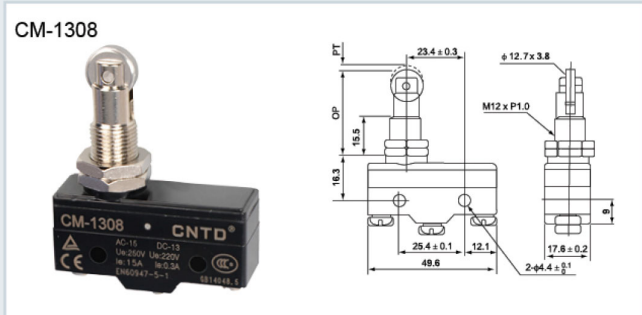
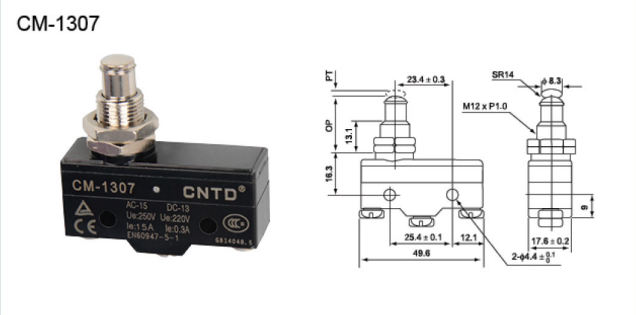
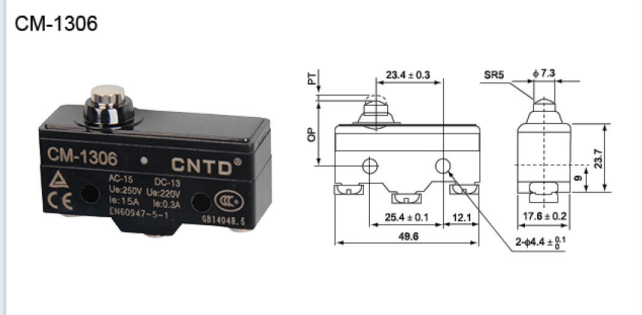
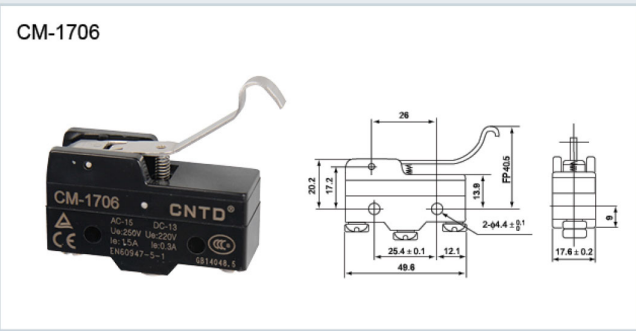
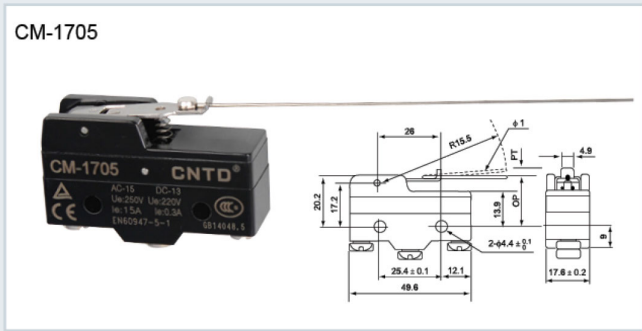

# CM 卧式限位开关 Horizontal Limit Switch

## 外观和尺寸 Appearance and Dimension

CM-1301

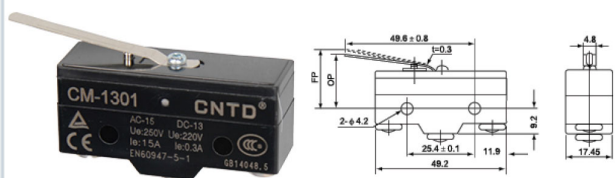

CM-1303

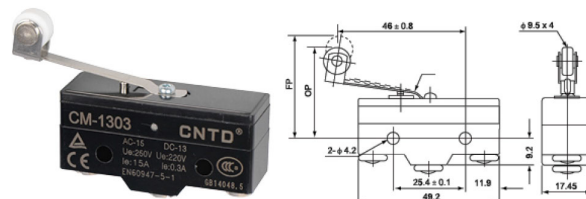

CM-1303M

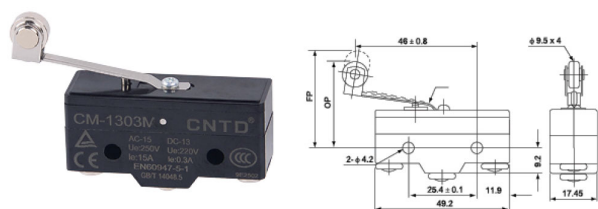

CM-1305

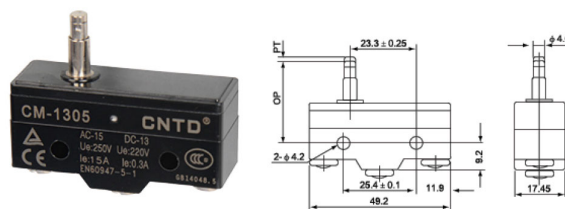

## 端子保护罩 Terminal Cover

CAP-Y



CAP-C



CAP-B

